

WUHAN YANXI MICRO-COMPONENT CO.,LTD.			
DATE	July. 22. 2020	System	
Part Number	SR405MF5A001	Version 1.0	Original

403MHz-408MHz Filter Standard Specifications

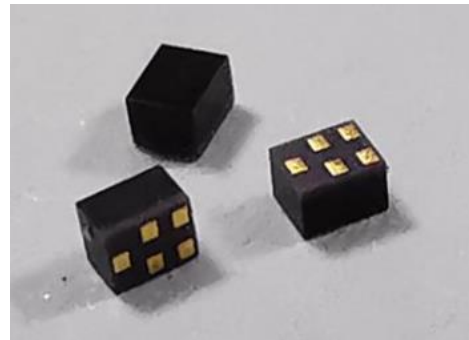

Product Features

- Typical insertion loss in the pass band is less than 3.0dB
- Plastic Chip Scale Package(CSP)
- Miniature Size
 - 1.1 mm X 0.9 mm Footprint
 - 0.6mm Max Height
- RoHS compliant, Pb-free

Applications

- 403MHz-408MHz bandpass filter
- Handsets
- Portable Hotspots
- Mobile Routers
- Smart Meters
- Access Points

Description

It is a high-performance, high power Surface Acoustic Wave (SAW) band-pass filter with extremely steep skirts, simultaneously exhibiting low loss in the 403-408MHz band.

Matching circuit

Input terminating impedance

$Z_{IN} = 50 \Omega$ with series 1 nH

Output terminating impedance

$Z_{OUT} = 50 \Omega$

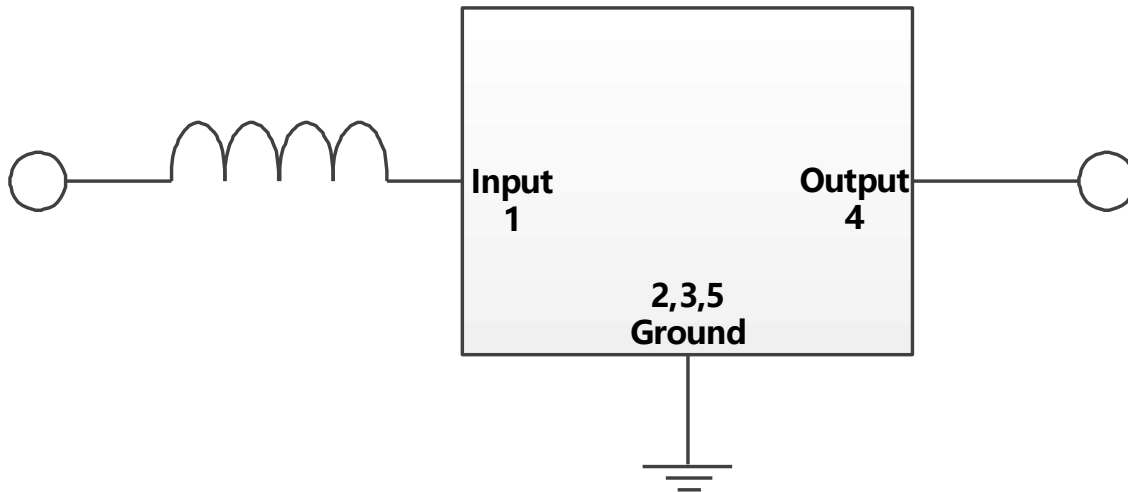

General Description

Pin No.	Symbol	DESCRIPTION
1	IN	RF input
2	GND	Ground connection
3	GND	Ground connection
4	OUT	ANT Antenna Port
5	GND	Ground connection

Top View

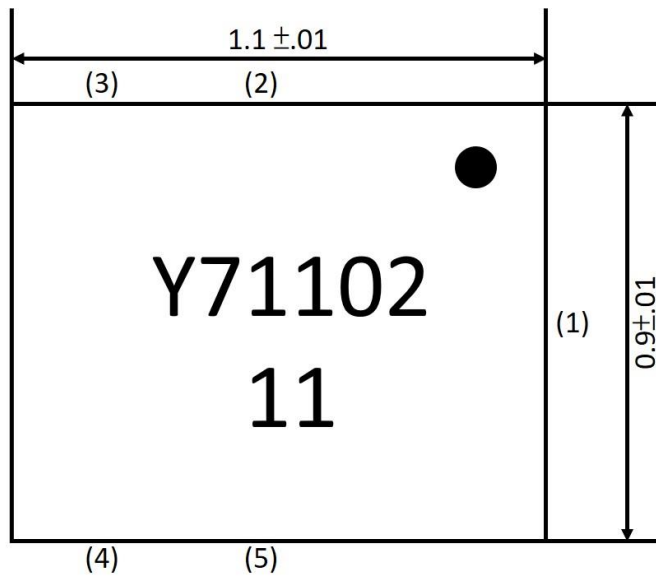

Bottom View

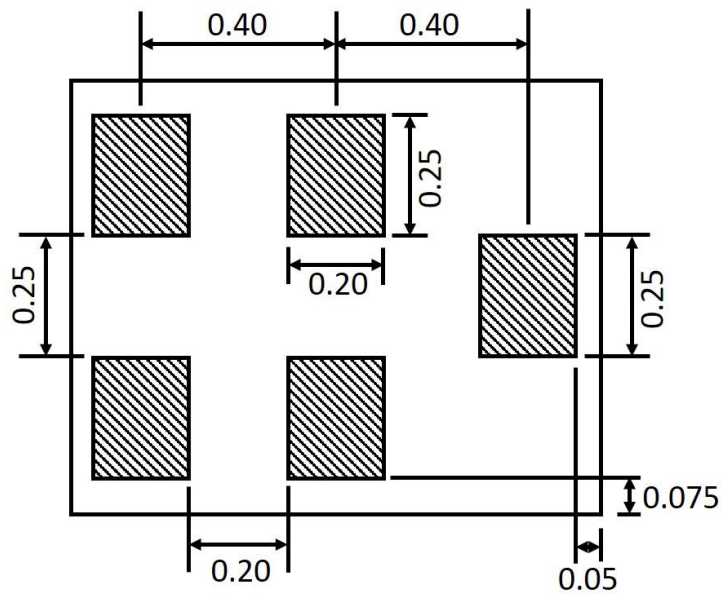

Side View

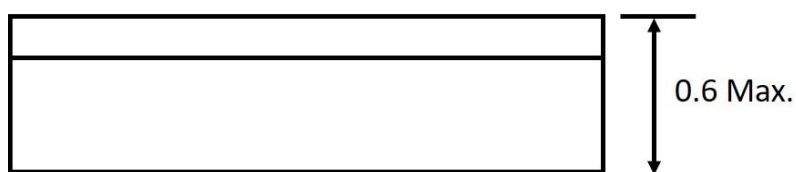

Electrical Specifications

Characteristics	Unit	Min	Typ ⁽¹⁾	Max
Bandpass Filter (403~408 MHz)		@+25° C		
Insertion Loss		dB		
Insertion loss	403~408MHz	-	3.0	3.0@-40~+85°C
Amplitude Ripple	403~408 MHz	-	1.0	2.0@-40~+80°C
Input / Output VSWR	403~408 MHz	-	-	2.0
Minimum Attenuation		dB		
	DC~395MHz	45	50	-
	413~418MHz	30	43	-
	418~430MHz	40	45	
	430~800MHz	50	55	
	800~1500MHz	45	50	-
	1500~2000MHz	25	30	-
Input / Output				
Input / Output Impedance		Ω	50	
Maximum Input Power		dBm	20	-
Operating Conditions				
Operating Temperature		°C	-40°C ~ +85°C	
Relative Humidity		%	10% ~ 90%	
Air Pressure		KPa	86 ~ 106	

(1) : The typical value is average value of each frequency band.

Transmission coefficient

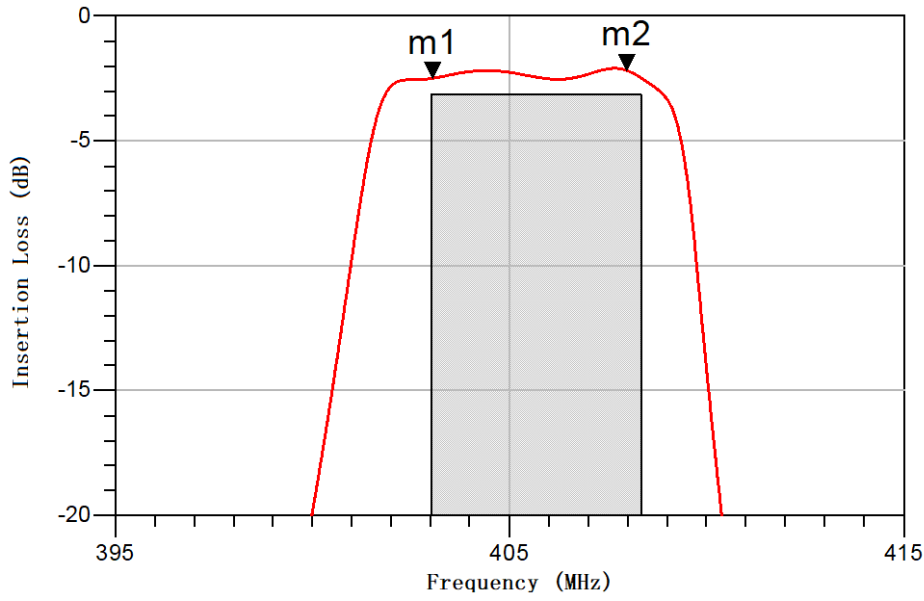

m1
freq=403.0MHz
dB(S(2,1))=-2.504

m2
freq=408.0MHz
dB(S(2,1))=-2.189

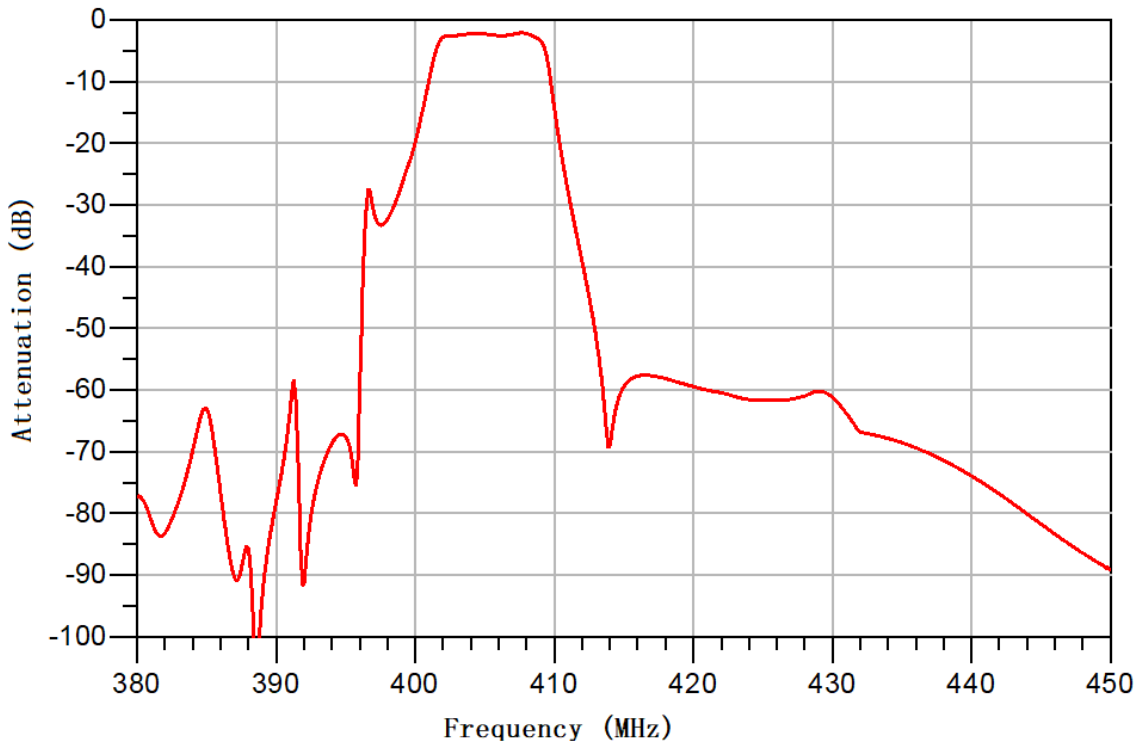

Reflection coefficients

Input Port

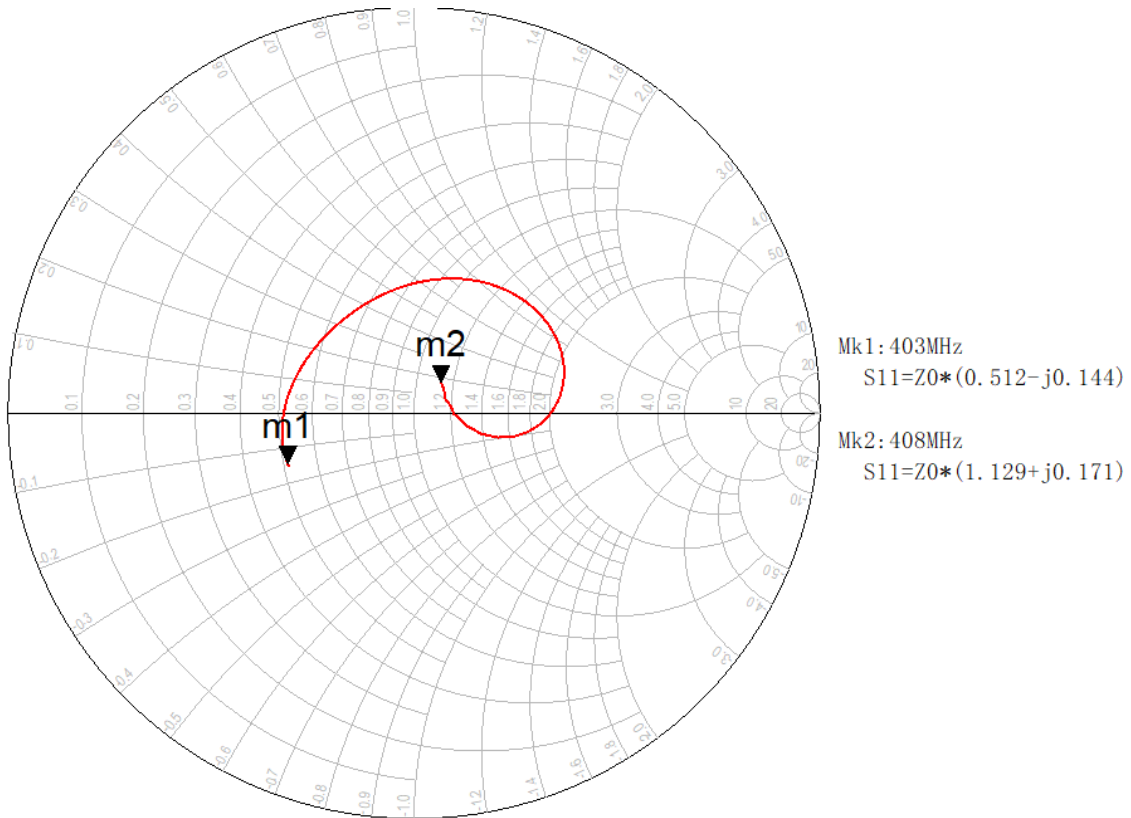
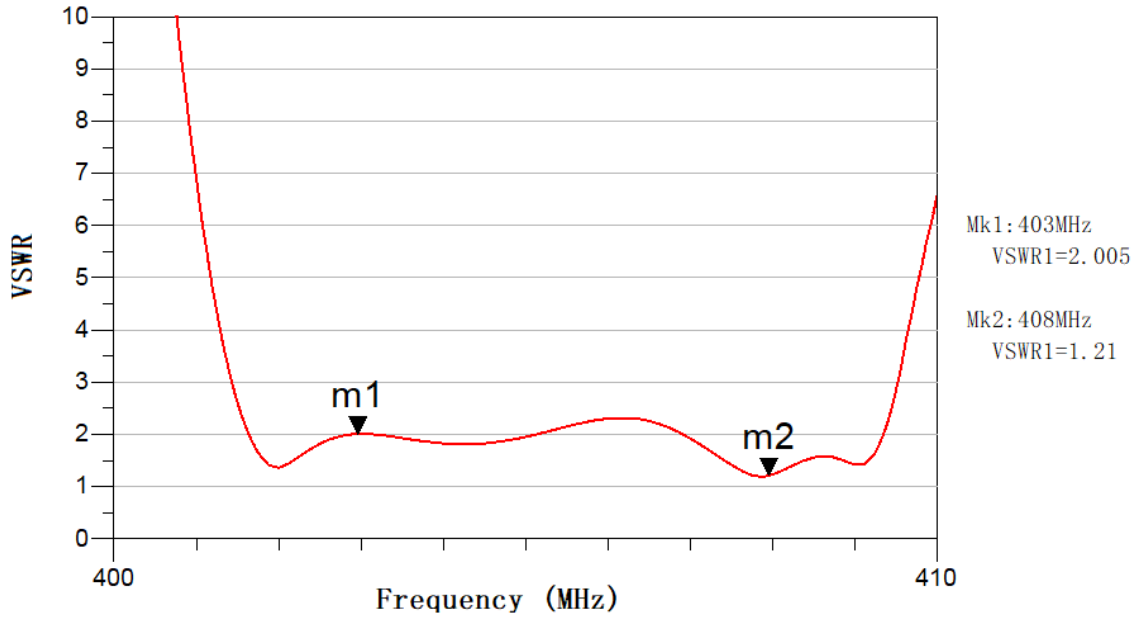

freq (403.0MHz to 408.0MHz)

Output Port

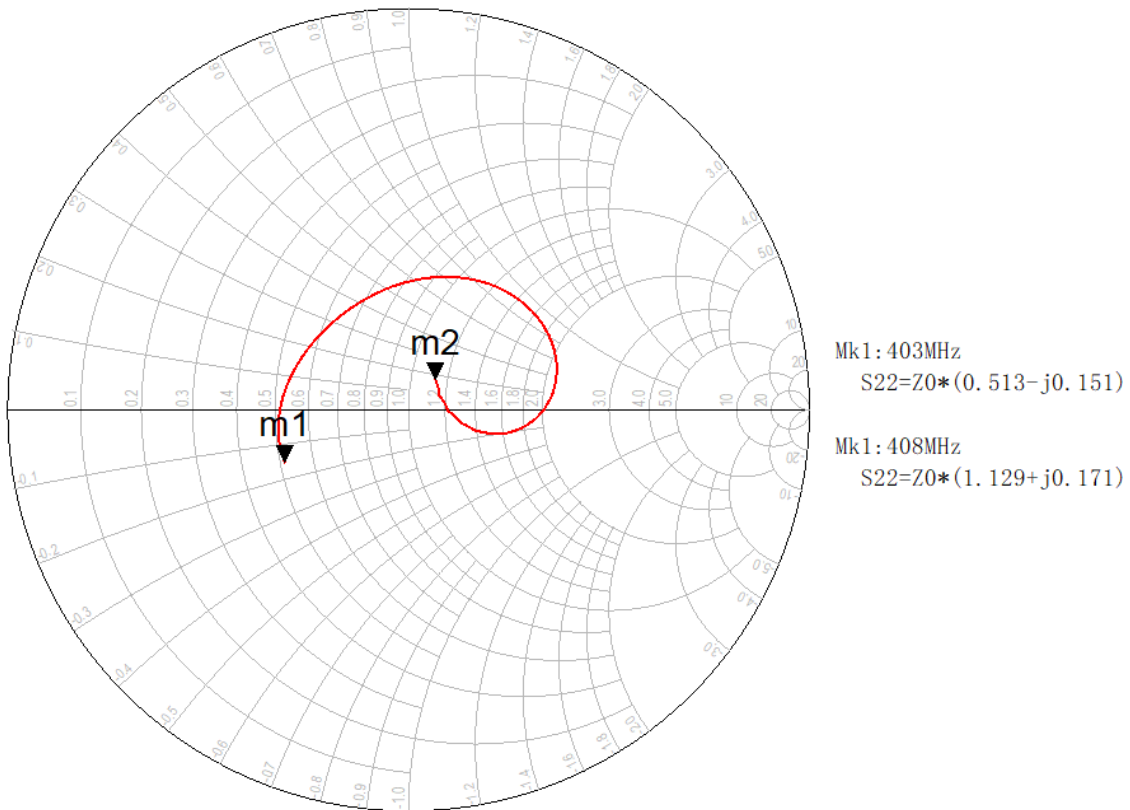
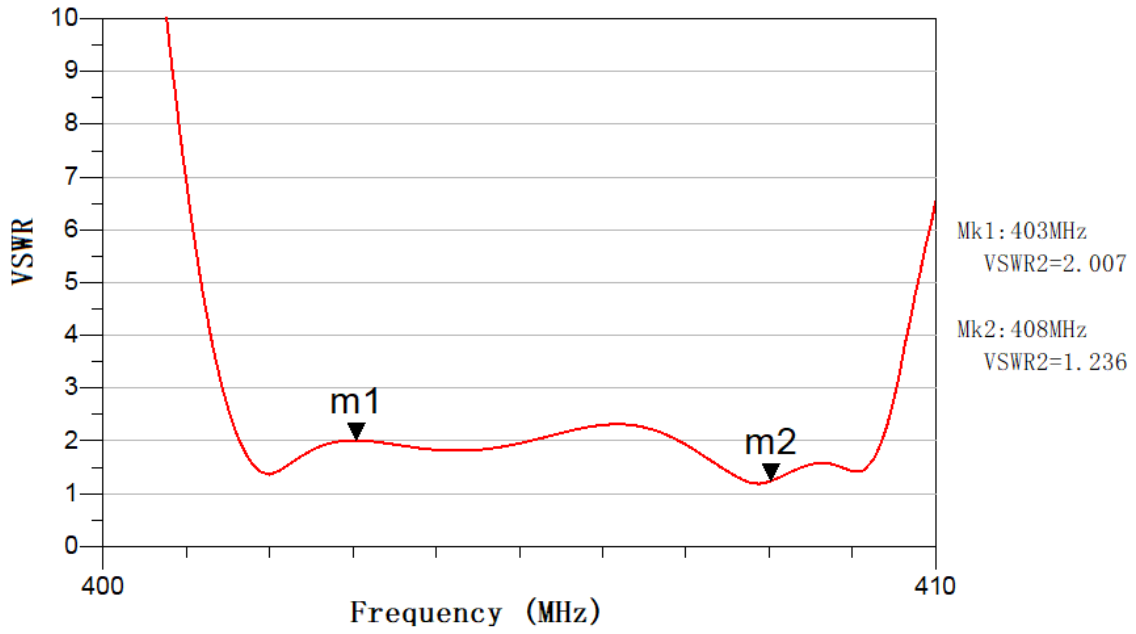

freq (403.0MHz to 408.0MHz)

Packing

(1).Leader part and vacant position specifications

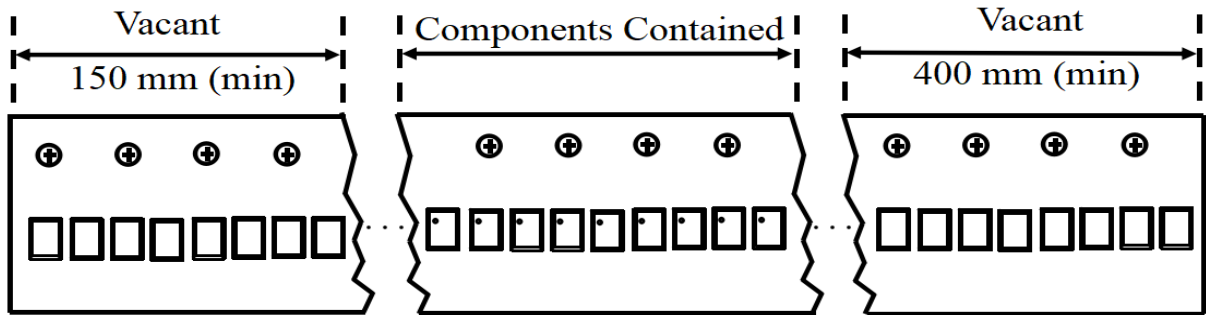

(2).Tape Specifications

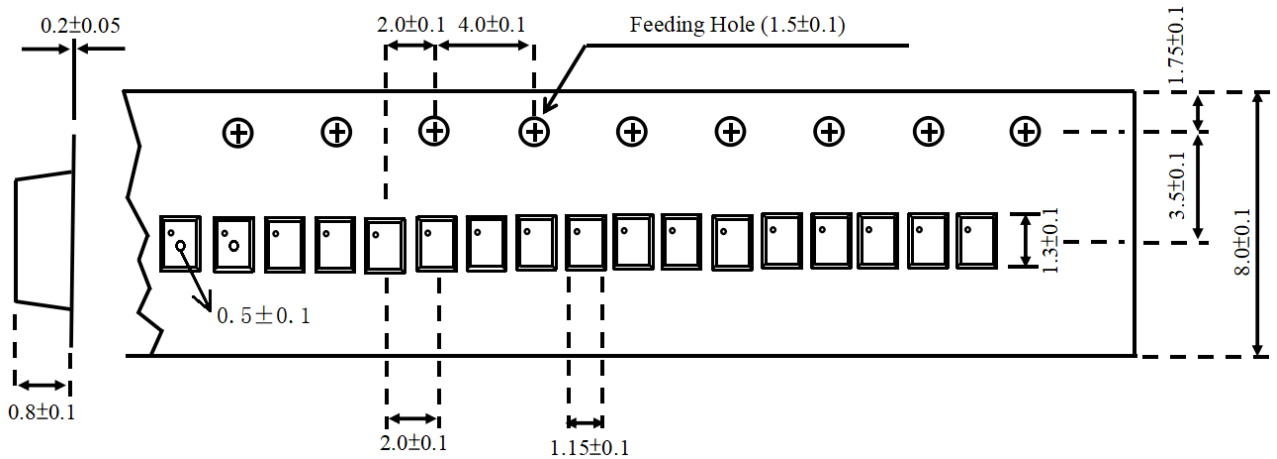

10000 pcs/reel ϕ 178mm

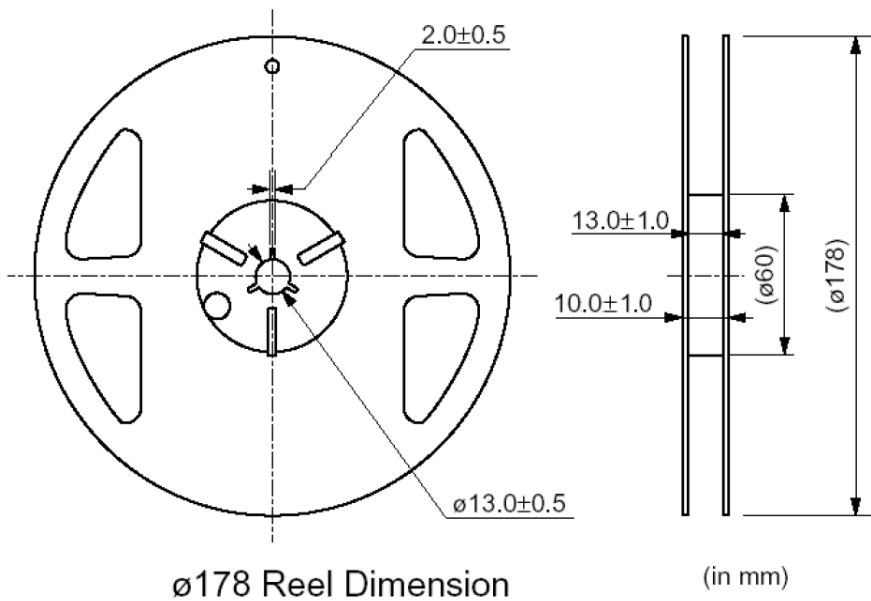

(3).Carton Box

Dimensions [mm]

X = 220+5

Y = 235+5

Sealing area 10 ±3

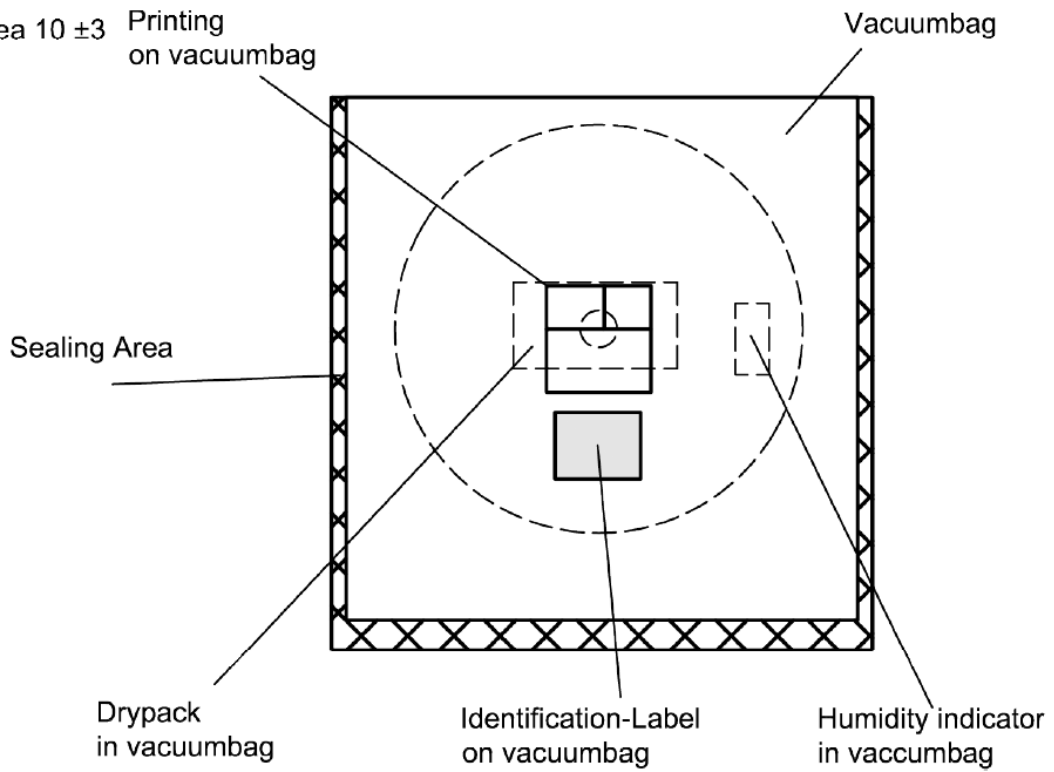

Drawing of moisture barrier bag (MBB) for reel with diameter of 178 mm

Dimensions [mm]

L = 188

B = 188

H = 30

Tolerance ±5

2 pcs. ESD label
(around carton box)

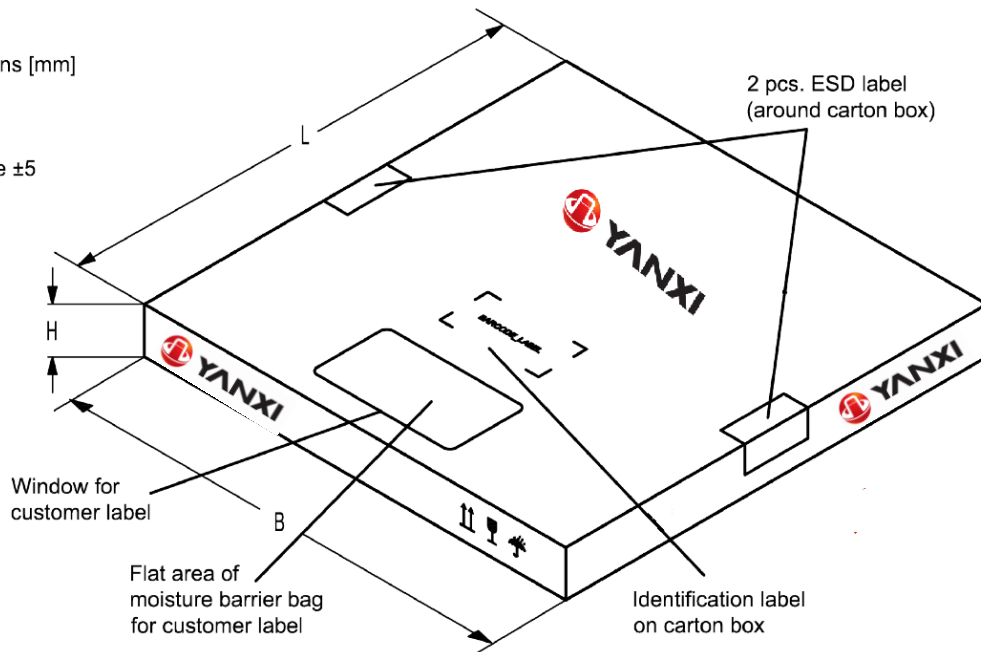

Drawing of folding box for reel with diameter of 178 mm

History Record

Date	Spec.NO.	Part NO.	Modify Content	Remark

Contact Information

Wuhan YanXi Micro-Component., Ltd.

- **Address:** No.19 Canglongdao, Jiangxia District, Wuhan City, Hubei Province, PRC
- **Tel:** +86-27-86637939 +86 - 15827100103
- **Email:** market@yanximc.com xufan@yanximc.com