

WUHAN YANXI MICRO-COMPONENT CO.,LTD.			
DATE	July. 22. 2020	System	
Part Number	SR385MF5A001	Version 1.0	Original

## 380MHz-390MHz Filter Standard Specifications

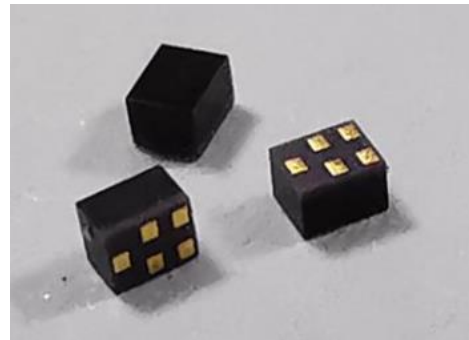

### Product Features

- Typical insertion loss in the pass band is less than 3.0dB
- Plastic Chip Scale Package(CSP)
- Miniature Size
  - 1.1 mm X 0.9 mm Footprint
  - 0.6mm Max Height
- RoHS compliant, Pb-free

### Applications

- 380MHz-390MHz bandpass filter
- Handsets
- Portable Hotspots
- Mobile Routers
- Smart Meters
- Access Points

### Description

It is a high-performance, high power Surface Acoustic Wave (SAW) band-pass filter with extremely steep skirts, simultaneously exhibiting low loss in the 380-390MHz band.

## Matching circuit

Input terminating impedance

$Z_{IN} = 50 \Omega$  with series 1 nH

Output terminating impedance

$Z_{OUT} = 50 \Omega$

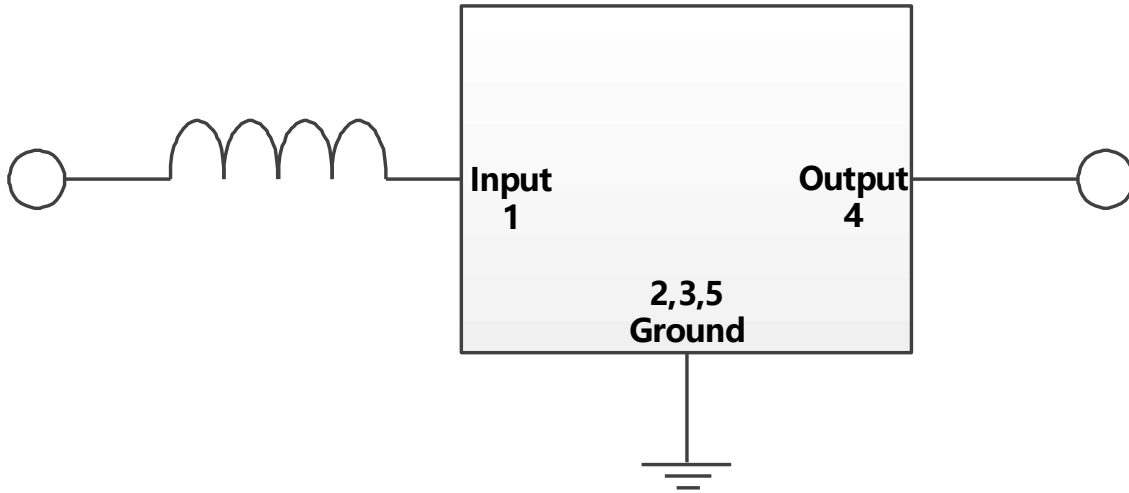

## General Description

Pin No.	Symbol	DESCRIPTION
1	IN	RF input
2	GND	Ground connection
3	GND	Ground connection
4	OUT	ANT Antenna Port
5	GND	Ground connection

### Top View

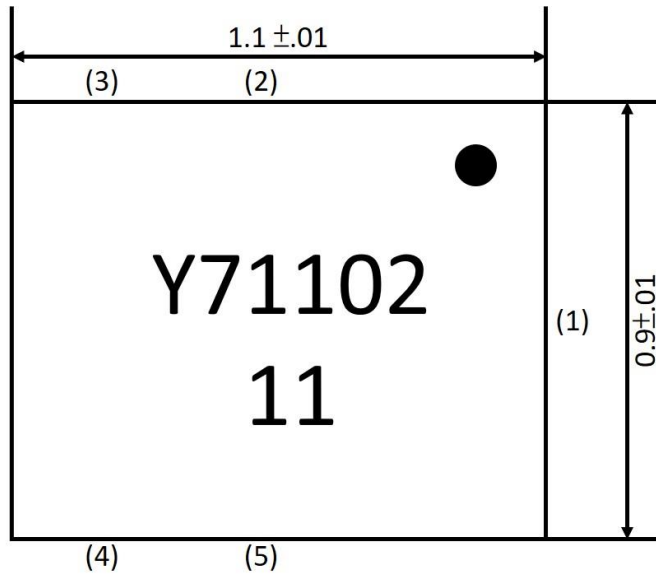

### Bottom View

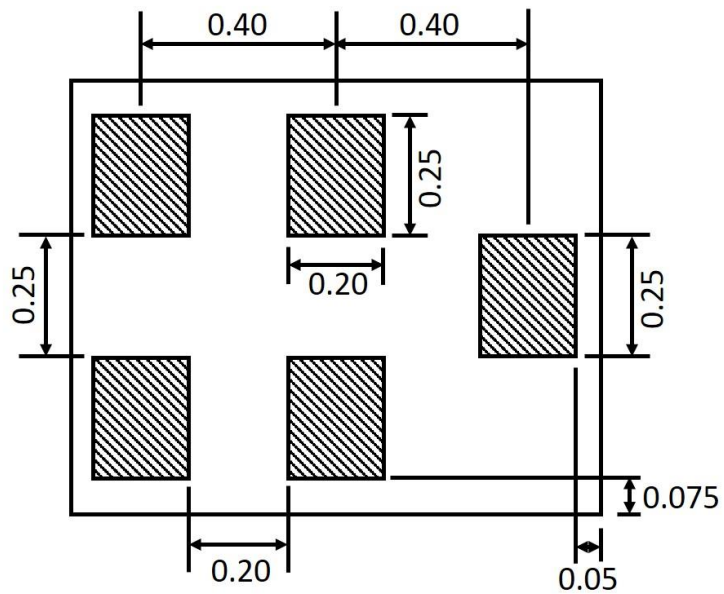

### Side View

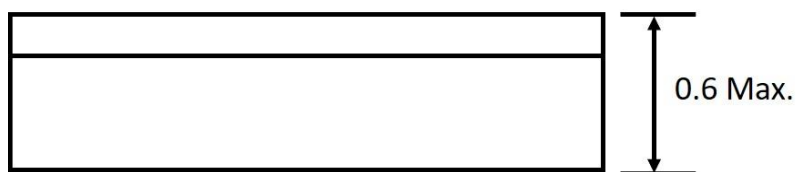

## Electrical Specifications

Characteristics	Unit	Min	Typ <sup>(1)</sup>	Max
<b>Bandpass Filter (380~390 MHz)</b>		<b>@+25° C</b>		
<b>Insertion Loss</b>		<b>dB</b>		
Insertion loss	380~390MHz	-	3.0	3.0@-40~+85°C
Amplitude Ripple	380~390MHz	-	1.0	2.0@-40~+85°C
Input / Output VSWR	380~390MHz	-	-	2.0
<b>Minimum Attenuation</b>		<b>dB</b>		
	0.3~360MHz	40	50	-
	410~1500MHz	40	50	-
<b>Input / Output</b>				
Input / Output Impedance		<b>Ω</b>	50	
Maximum Input Power		<b>dBm</b>	20	-
<b>Operating Conditions</b>				
Operating Temperature		<b>°C</b>	-40°C ~ +85°C	
Relative Humidity		<b>%</b>	10% ~ 90%	
Air Pressure		<b>KPa</b>	86 ~ 106	

(1) : The typical value is average value of each frequency band.

### Transmission coefficient

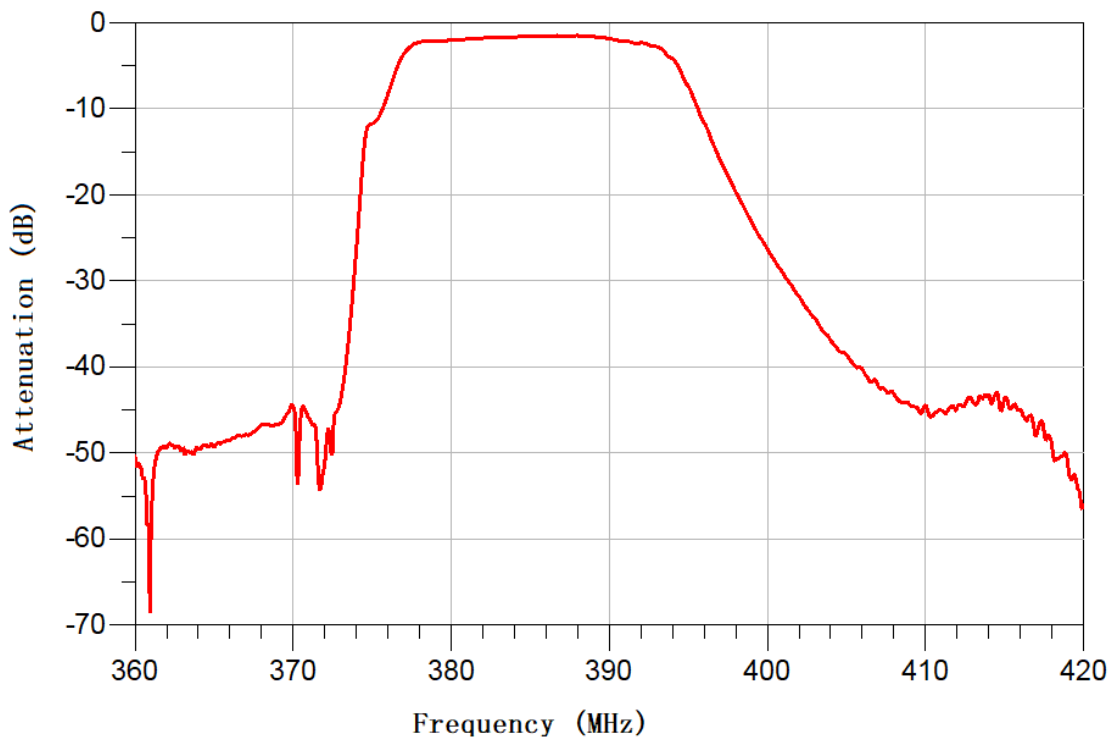
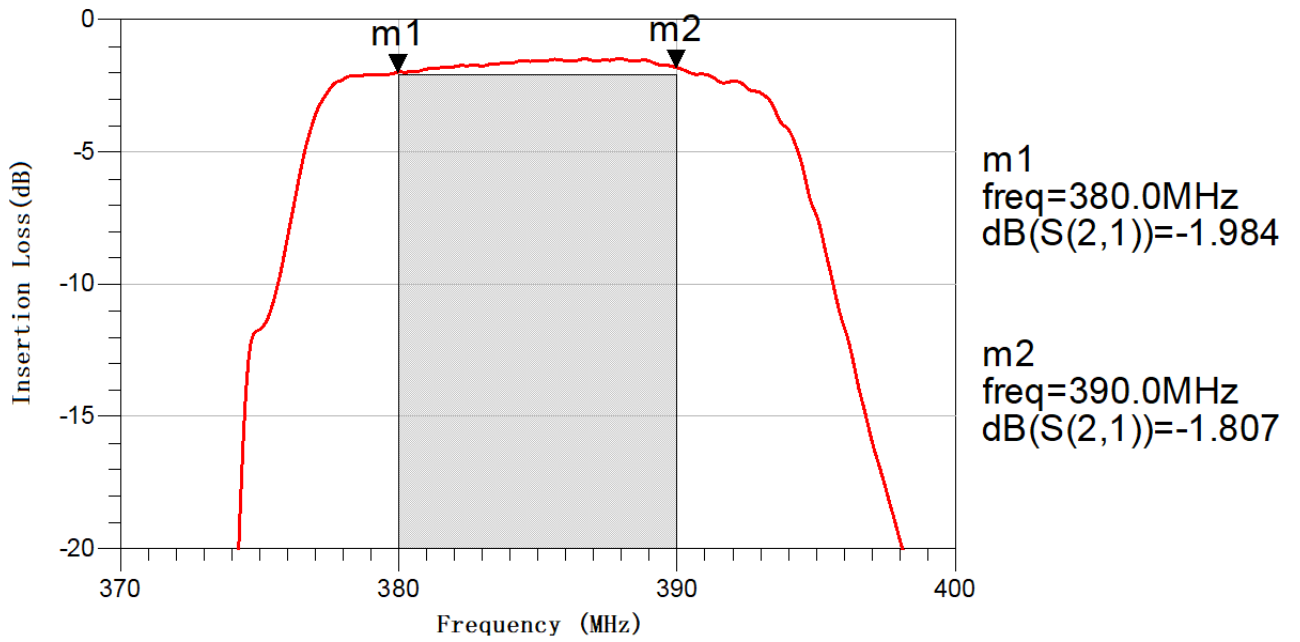

## Reflection coefficients

### Input Port

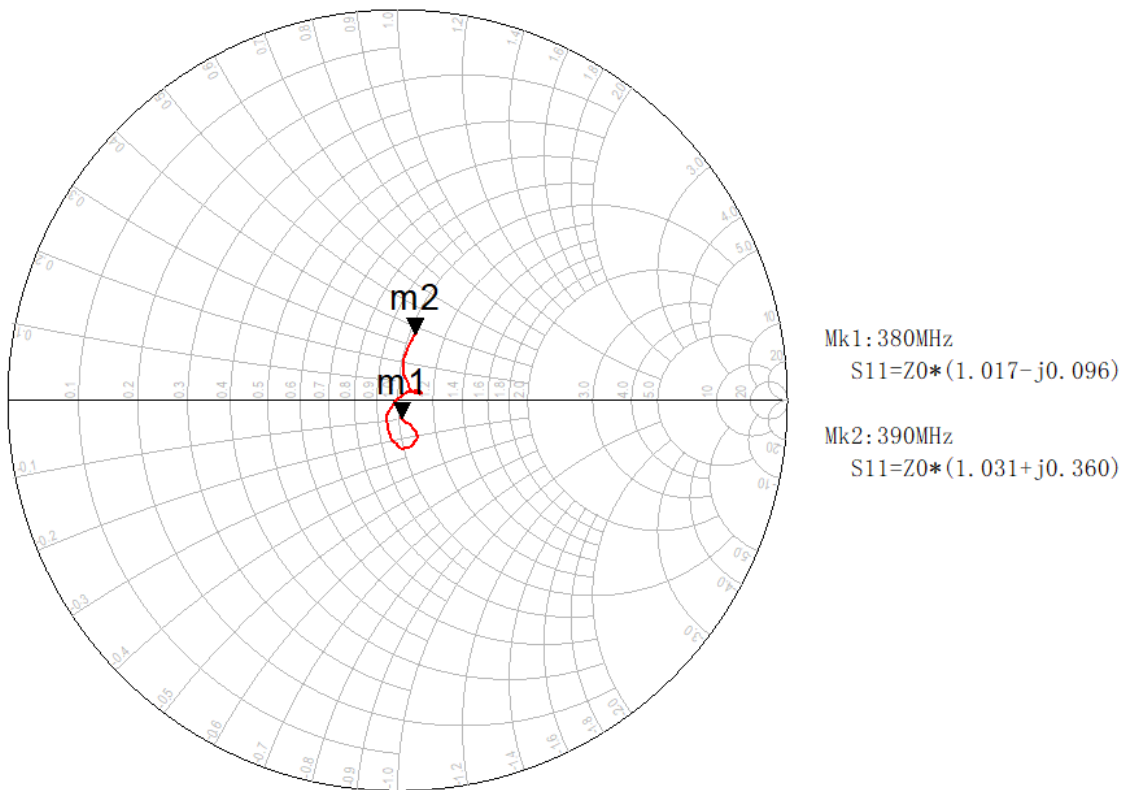
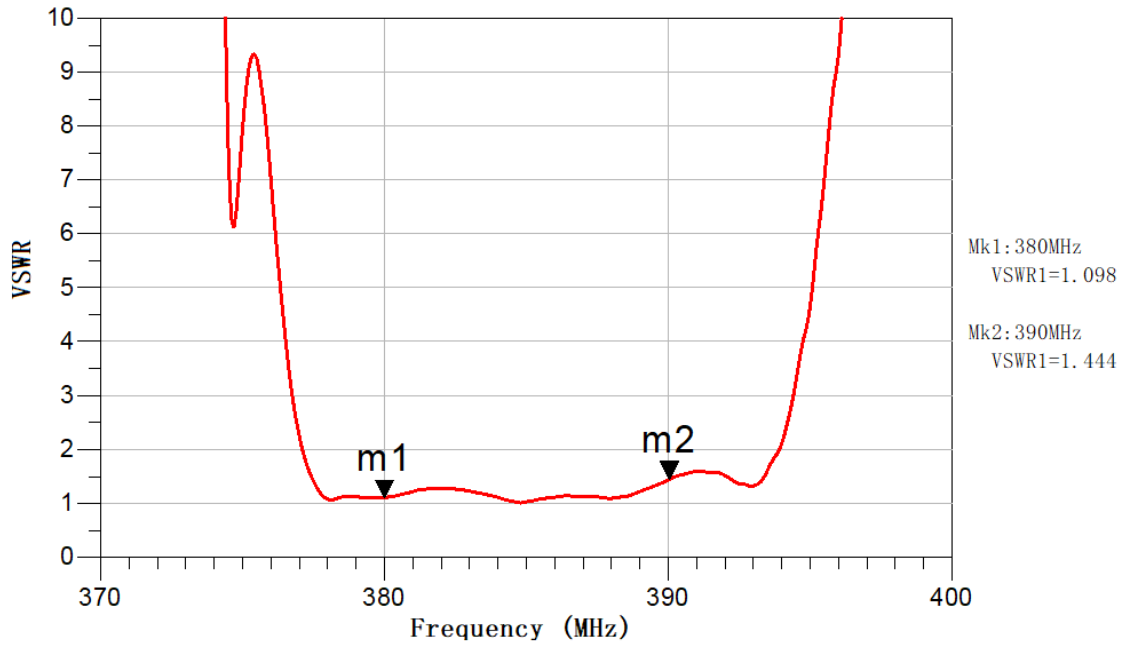

freq (380.0MHz to 390.0MHz)

### Output Port

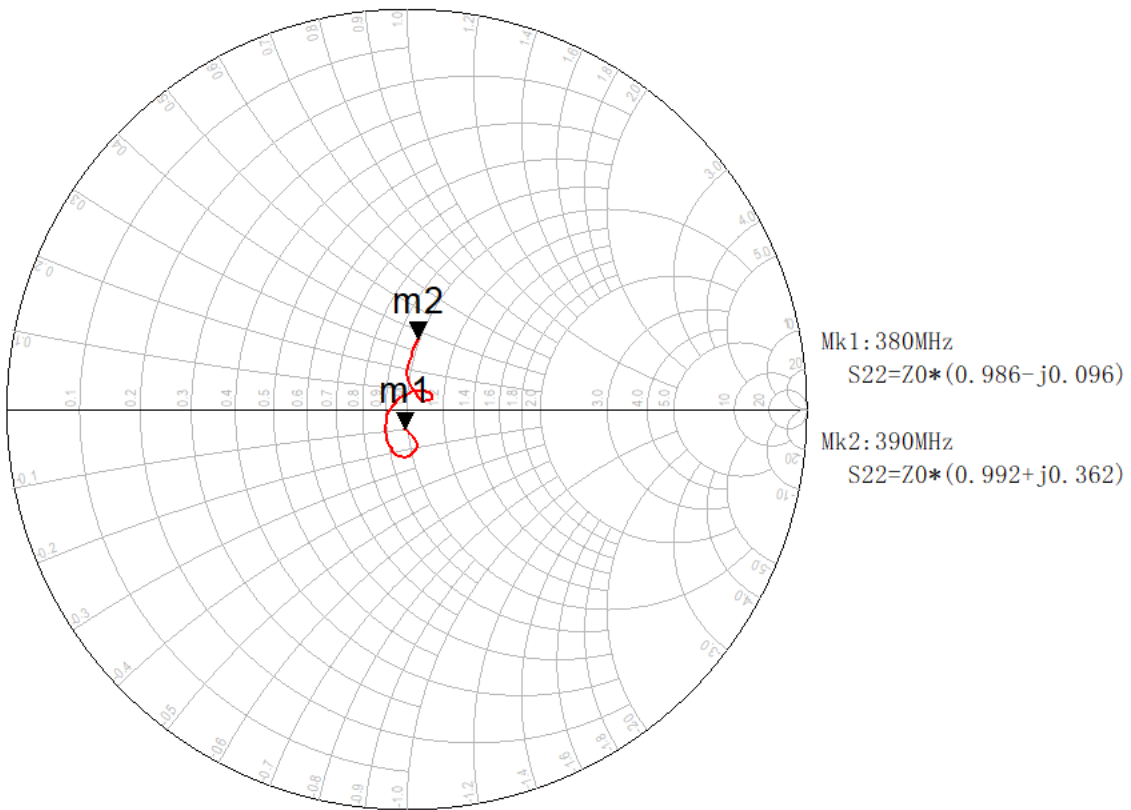
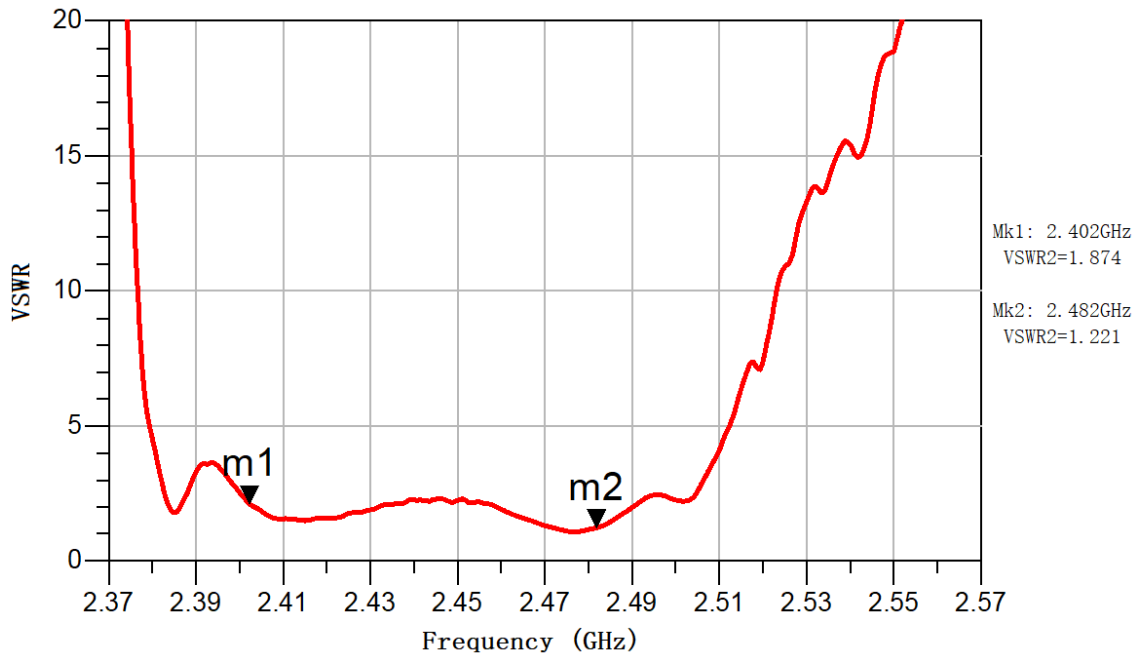

freq (380.0MHz to 390.0MHz)

## Packing

### (1).Leader part and vacant position specifications

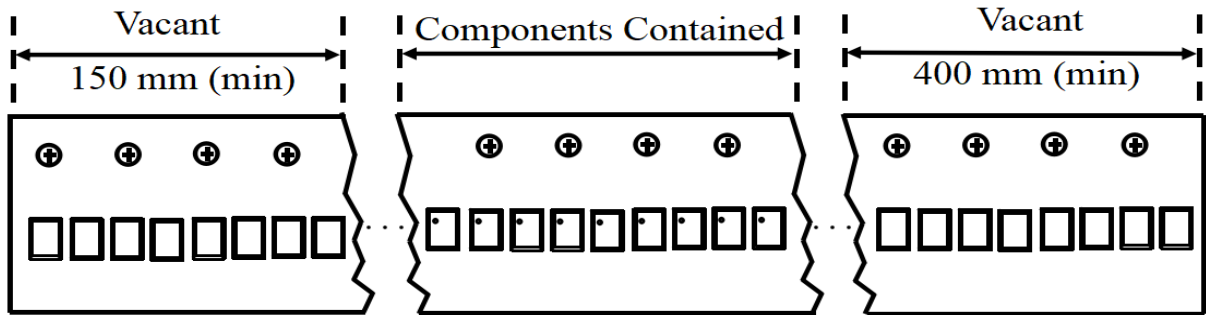

### (2).Tape Specifications

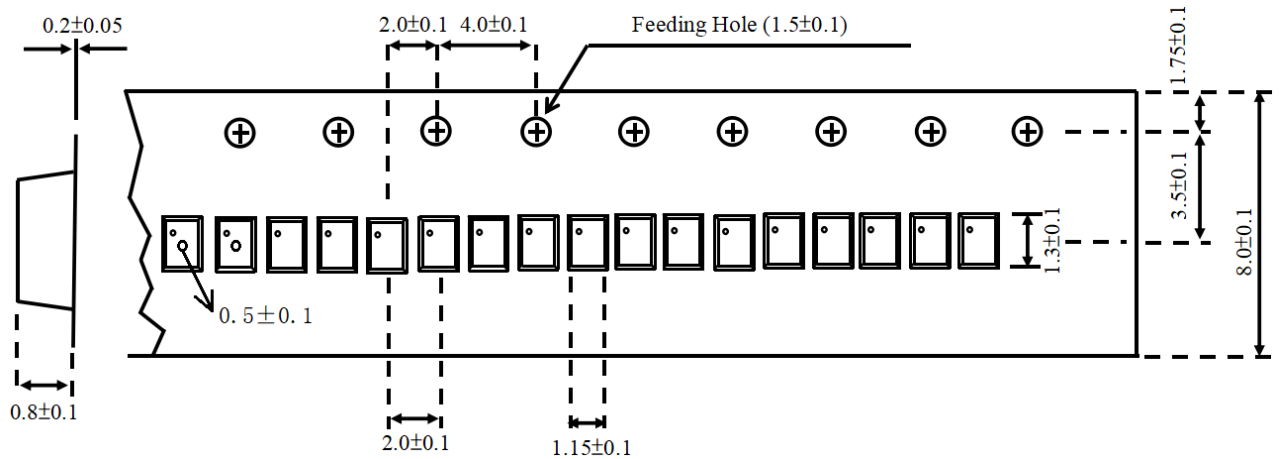

10000 pcs/reel  $\phi$  178mm

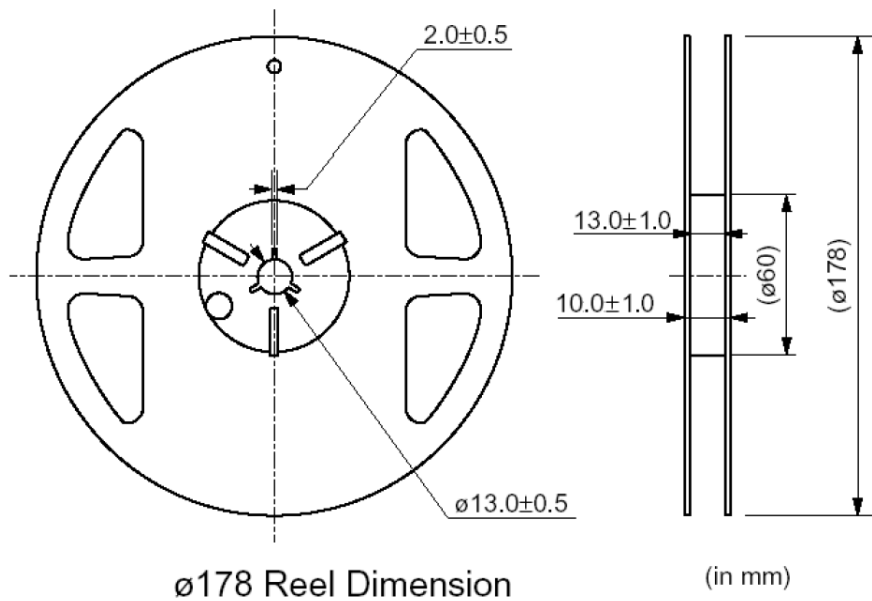



**(3).Carton Box**

Dimensions [mm]

X = 220+5

Y = 235+5

Sealing area 10 ±3

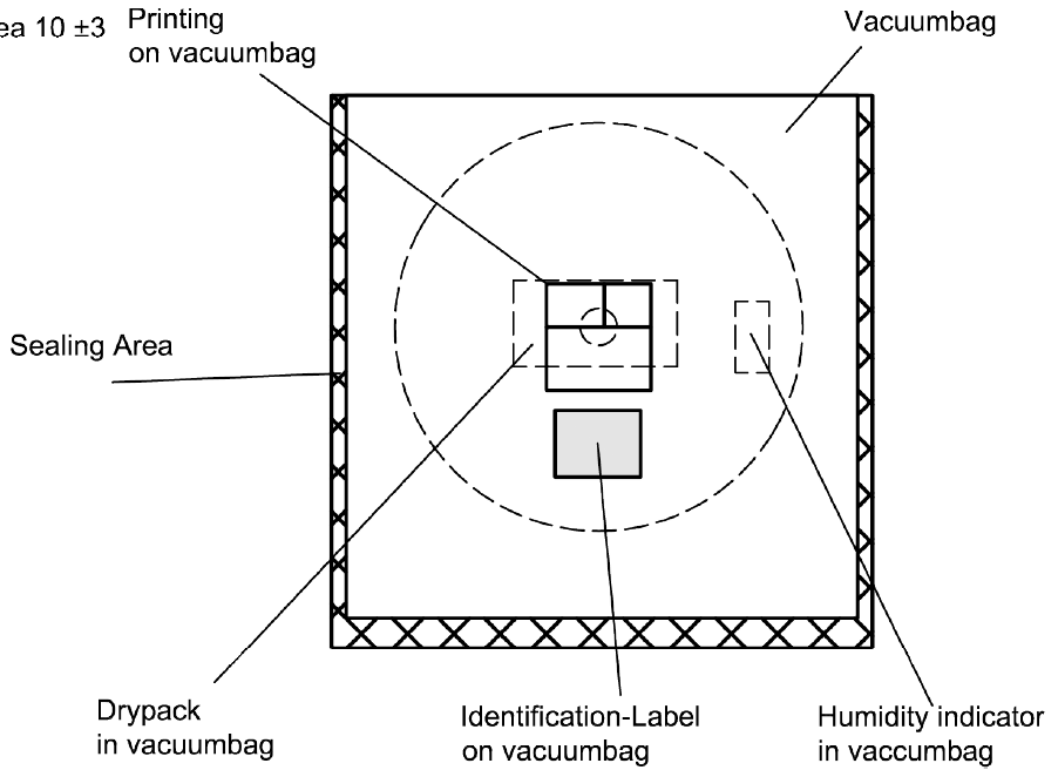

Drawing of moisture barrier bag (MBB) for reel with diameter of 178 mm

Dimensions [mm]

L = 188

B = 188

H = 30

Tolerance ±5

2 pcs. ESD label  
(around carton box)

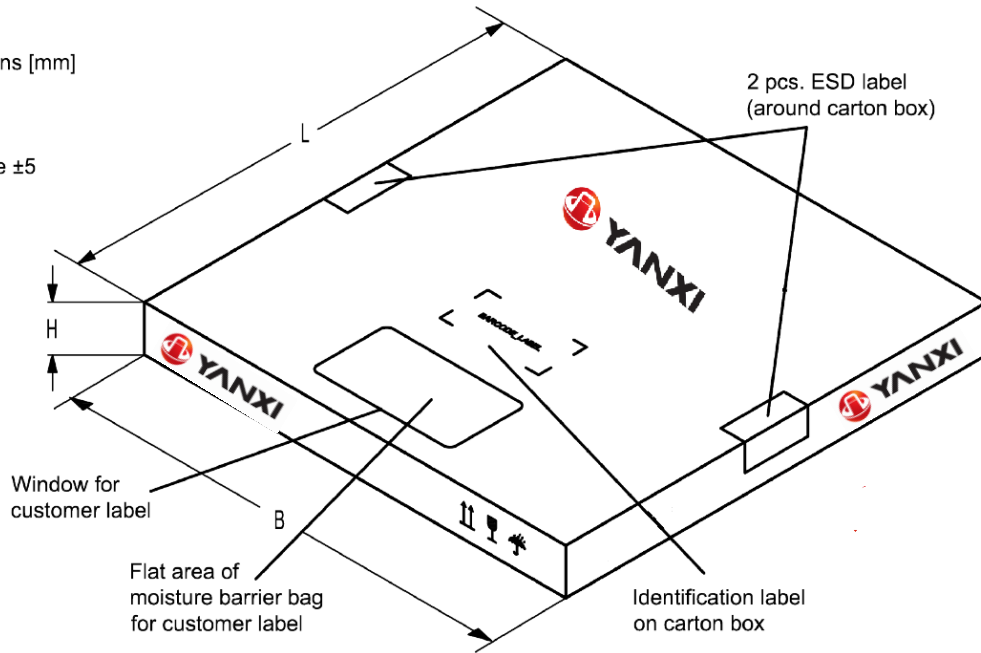

Drawing of folding box for reel with diameter of 178 mm

---

## History Record

Date	Spec.NO.	Part NO.	Modify Content	Remark

---

## Contact Information

**Wuhan YanXi Micro-Component., Ltd.**

- **Address:** No.19 Canglongdao, Jiangxia District, Wuhan City, Hubei Province, PRC
- **Tel:** +86-27-86637939      +86 - 15827100103
- **Email:** [market@yanximc.com](mailto:market@yanximc.com)      [xufan@yanximc.com](mailto:xufan@yanximc.com)